

# FilterTable GWT

Art. No.: 95 0400 020



## Technical Data

Filter	
Filter stages	2
Filter method	Storage Filter
Filter surface	15,8 m <sup>2</sup>
Type of filter	Filter cassette
Filter material	Non-woven fibre
Filter class	F9
Additional filters	Pre-filter (aluminium)
Basic data	
Extraction capacity	1400 m <sup>3</sup> /h
Maximum vacuum	3.000 Pa
Dimensions (w x t x h)	1200 x 800 x 970 mm
Weight	245 kg
Motor power	1,5 kW
Power supply	3 x 400 V / 50 Hz
Rated current	3,2 A
Noise level	71 dB(A)
Additional information	
Fan type	Radial fan

## Applications

- Low to medium levels of smoke and dust
- Occasional to frequent use
- Cobot applications
- Welding and grinding

## Benefits

- Maintenance door allows easy filter change
- Effective spark protection ensures maximum safety
- Clamping options via clamping hole Ø 16mm
- Downdraft extraction throughout the whole working area
- Wide range of applications due to large working area of 1,200 x 800 mm
- Dense bore grid 50mm
- Smooth repositioning by means of rollers

## Properties

- Large, robust material support
- Activated charcoal filter (optional)
- Load capacity up to 1000kg (static)
- Down-draft system
- Protective wall enclosure (optional)

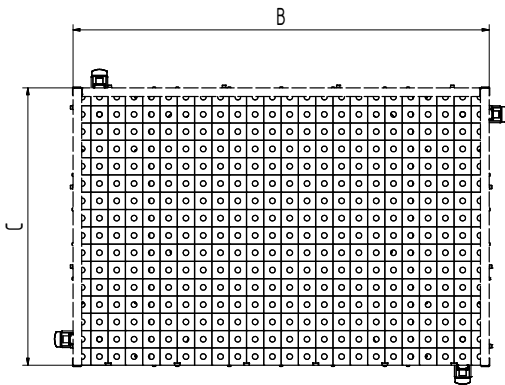
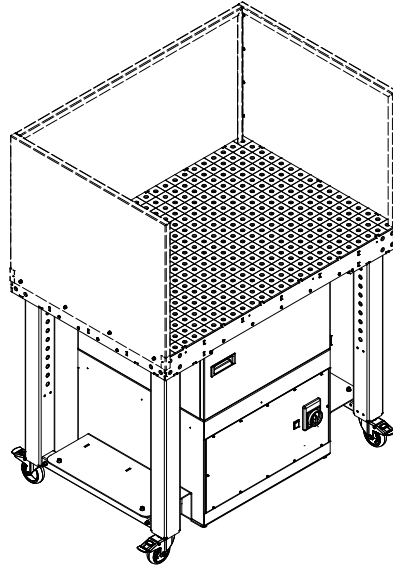
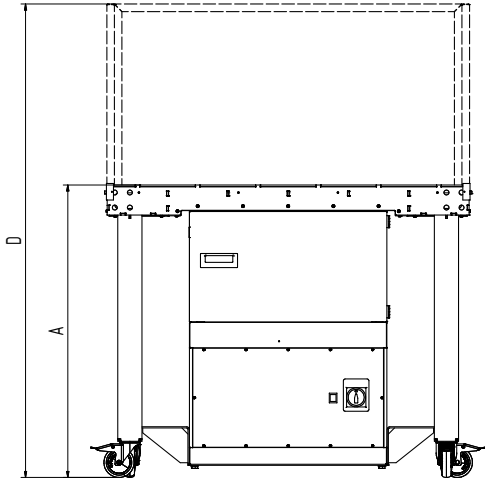

## Technical Data

### Dimensions

A	970 mm
B	1.200 mm
C	803 mm
D	1.570 mm

The protective screen shown is optionally available